

## Inductive sensor NBB20-L2-Z5-V1

- Sensor head bidirectional and rotatable
- 20 mm flush
- Quick mounting bracket

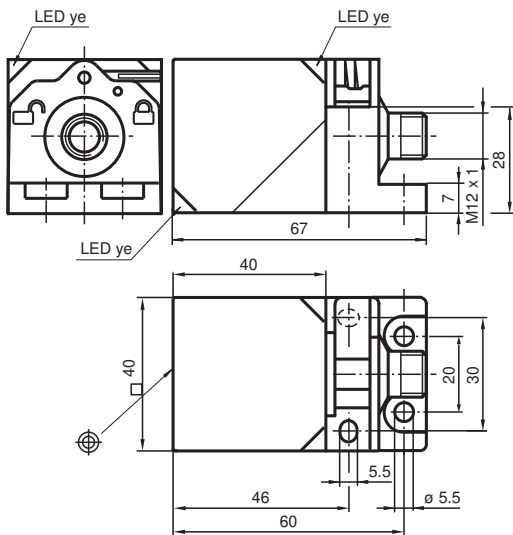

### Dimensions



### Technical Data

#### General specifications

Switching function		Normally closed (NC)
Output type		Two-wire
Rated operating distance	$s_n$	20 mm
Installation		flush
Output polarity		DC
Assured operating distance	$s_a$	0 ... 16.2 mm
Actual operating distance	$s_r$	18 ... 22 mm
Reduction factor $r_{Al}$		0.33
Reduction factor $r_{Cu}$		0.31
Reduction factor $r_{304}$		0.74
Reduction factor $r_{Brass}$		0.41
Output type		2-wire

#### Nominal ratings

Release date: 2022-06-22 Date of issue: 2022-06-22 Filename: 182170\_eng.pdf

Refer to "General Notes Relating to Pepperl+Fuchs Product Information".

Pepperl+Fuchs Group  
www.pepperl-fuchs.com

USA: +1 330 486 0001  
fa-info@us.pepperl-fuchs.com

Germany: +49 621 776 1111  
fa-info@de.pepperl-fuchs.com

Singapore: +65 6779 9091  
fa-info@sg.pepperl-fuchs.com

 PEPPERL+FUCHS

## Technical Data

Operating voltage	$U_B$	3.8 ... 30 V DC
Switching frequency	$f$	0 ... 30 Hz
Reverse polarity protection		reverse polarity protected
Short-circuit protection		yes
Voltage drop	$U_d$	$\leq 3.8$ V
Voltage drop at $I_L$		
Voltage drop $I_L = 100$ mA, switching element on	$U_d$	... 3.8 V
Operating current	$I_L$	2 ... 100 mA
Off-state current	$I_r$	0 ... 0.5 mA
Switching state indicator		LED, yellow
<b>Compliance with standards and directives</b>		
Standard conformity		
Standards		EN 60947-5-2:2007 IEC 60947-5-2:2007
<b>Approvals and certificates</b>		
UL approval		cULus Listed, General Purpose
CSA approval		cCSAus Listed, General Purpose
CCC approval		CCC approval / marking not required for products rated $\leq 36$ V
<b>Ambient conditions</b>		
Ambient temperature		-25 ... 70 °C (-13 ... 158 °F)
Storage temperature		-25 ... 85 °C (-13 ... 185 °F)
<b>Mechanical specifications</b>		
Connection type		Connector plug M12 x 1 , 4-pin
Housing material		PA
Sensing face		PA
Degree of protection		IP69K
Mass		130 g

## Connection

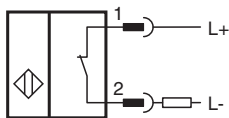

## Connection Assignment

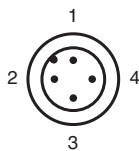





## Connection Assignment

Wire colors in accordance with EN 60947-5-2

1	BN	(brown)
2	WH	(white)
3	BU	(blue)
4	BK	(black)

## Accessories

	<b>V1-G-2M-PUR</b>	Female cordset single-ended M12 straight A-coded, 4-pin, PUR cable grey
	<b>V1-W-2M-PUR</b>	Female cordset single-ended M12 angled A-coded, 4-pin, PUR cable grey
	<b>MHW 01</b>	Modular mounting bracket
	<b>MH 02-L</b>	Mounting aid for VariKont-L